

Radio / CD

# Heidelberg CD50

## Operating instructions



 **BLAUPUNKT**

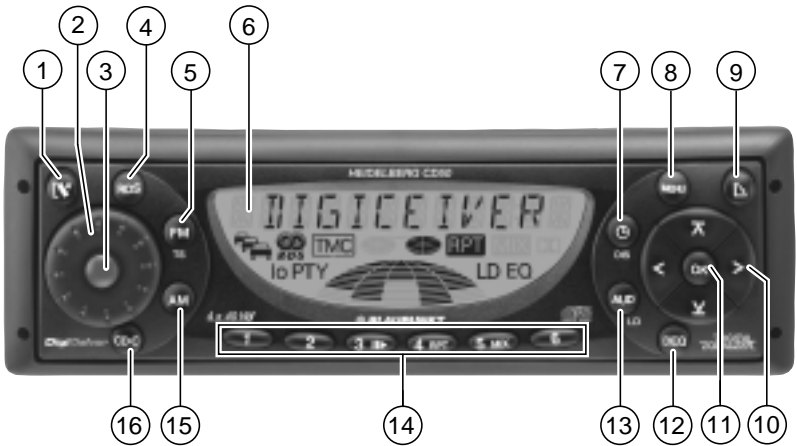

## OPERATING ELEMENTS

---

- ① **LOCK** button to unlock release panel
- ② Volume control
- ③ ON button, switches the unit on/off, mute
- ④ **RDS** button, switches the RDS function on/off  
Selects display for variable text
- ⑤ **FM** button, selects the FM waveband and the FM memory bank  
**TS**, starts the TravelStore function
- ⑥ Display
- ⑦ **CLOCK** button, displays the time  
**DIS**, changes display contents
- ⑧ **MENU** button, accesses the menu for basic settings
- ⑨ **FLIP** button, opens the flip release panel
- ⑩ Cursor button block
- ⑪ **OK** button, confirms menu selections and starts the SCAN function
- ⑫ **DEQ** button, adjusts the equalizer
- ⑬ **AUD** button, adjusts bass, treble, balance and fader  
**LD**, switches the Loudness function on/off
- ⑭ **1 to 6** station buttons
- ⑮ **AM** button, selects the AM waveband
- ⑯ **CD•C** button, switches sound source between radio, CD player and CD changer (if connected)

<b>Important information</b> .....	<b>6</b>	Playing tracks in random order (MIX) .....	14
Traffic safety .....	6	Scanning tracks (SCAN) .....	14
Installation .....	6	Repeating individual tracks (REPEAT) .....	15
Accessories .....	6	Interrupting playback (PAUSE) .....	15
Guarantee .....	6	Switching the display mode .....	15
International telephone information ...	6	Naming CDs .....	15
<b>Removable front panel</b> .....	<b>7</b>	Removing the CD .....	16
<b>Switching the car audio system on/off</b> .....	<b>8</b>	<b>CD changer operation</b> .....	<b>16</b>
<b>Volume control</b> .....	<b>9</b>	Starting CD changer operation .....	16
Adjusting the power-on volume .....	9	Selecting CDs .....	16
Mute .....	9	Selecting tracks .....	16
Telephone audio/Navigation audio ....	9	Audible fast forward/reverse (CUE/REVIEW) .....	16
Adjusting the volume of the beep ...	10	Switching the display mode .....	16
<b>Radio operation</b> .....	<b>10</b>	Repeating individual tracks or entire CDs (REPEAT) .....	17
Switching to the radio mode .....	10	Playing tracks in random order (MIX) .....	17
RDS function .....	10	Scanning all of the tracks on all of the CDs (SCAN) .....	17
Selecting the waveband/ memory bank .....	10	Interrupting playback (PAUSE) .....	17
Tuning into radio stations .....	11	Naming CDs .....	18
Adjusting seek tuning sensitivity ....	11	<b>Clock</b> .....	<b>19</b>
Storing radio stations .....	11	<b>Adjusting the tone and balance/fader</b> .....	<b>20</b>
Storing radio stations automatically (TravelStore) .....	11	<b>Switching Loudness on/off</b> ....	<b>21</b>
Recalling stored radio stations .....	12	<b>Equalizer</b> .....	<b>21</b>
Scanning the radio stations within reception range (SCAN) .....	12	Notes on making equalizer settings .	21
Adjusting the scan time .....	12	Switching the equalizer on/off .....	22
Optimising radio reception .....	12	Adjusting the equalizer .....	22
Selecting the display of variable text .....	13	Adjusting the spectrometer .....	22
Adjusting the tuner .....	13	Assistance in setting your equaliser .	23
<b>CD player operation</b> .....	<b>14</b>	<b>External audio sources</b> .....	<b>24</b>
Starting CD player operation .....	14	<b>Specifications</b> .....	<b>24</b>
Selecting tracks .....	14	<b>Installation instructions</b> .....	<b>92</b>
Audible fast forward/reverse (CUE/REVIEW) .....	14		

# IMPORTANT INFORMATION

---

## Important information

Before you use your car audio system for the first time, please take the time to read the instruction manual carefully and make yourself familiar with the audio equipment. Keep this manual handy in your car for future reference.

### Traffic safety

 Traffic safety is always the top priority. Do not attempt to operate your car audio system unless the traffic conditions permit. Familiarize yourself with the equipment before you start driving.

Always make sure that you are still able to hear any warning signals coming from outside the vehicle, such as police or fire engine sirens, at all times.

As a result, please always select a moderate volume for playing your car audio system while you are driving.

### Installation

If you would like to install your new car stereo yourself or add other audio components to the existing ones, then please read the instructions on installation and connection at the end of this manual carefully.

### Accessories

Use only Blaupunkt-approved accessories.

### Remote control unit

The optionally available RC 08 infrared remote control unit allows you to conveniently operate the most important

system functions from the steering wheel.

### Amplifiers

All Blaupunkt amplifiers can be used.

### CD changers

The following CD changers can be connected directly: CDC A 06, CDC A 08, CDC A 072 and IDC A 09.

The CDC A 05 and CDC A 071 can be connected with an adapter cable (Blaupunkt no. 7 607 889 093).

### Guarantee

The scope of the guarantee is determined by the laws in the country where the unit is purchased.

Regardless of the legal guarantee regulations, Blaupunkt affords a 12-month guarantee.

If you have any questions about the guarantee, please contact your authorised Blaupunkt dealer. Your cash register receipt is a valid guarantee coupon.

### International telephone information

Have you got any questions on the operation of this equipment or do you require more information?

Give us a call!

You will find the international telephone and fax numbers on the last page of this manual.

## Removable front panel

### Theft protection system

To prevent your car audio system from being stolen, it has been equipped with a removable front panel (flip release panel). Without the front panel, the car audio system is useless to thieves.

Protect your car audio system against theft and take the operating panel with you each time you leave the vehicle. Never leave the release panel in the car, even if it is well hidden. The panel has been designed so that it is easy to remove.

#### Notes:

- Do not drop the release panel.
- Do not expose the release panel to direct sunlight or other heat sources.
- Store the release panel in the case supplied.

### Removing the operating panel

- ⇒ Press  ①.

The release panel will unlock.

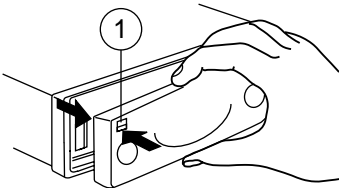

- ⇒ First pull the operating panel forward and then slide it to the left to remove it.

- When you remove the operating panel, the car audio system will automatically switch off.
- All of the settings will remain stored.
- A CD inserted into the car audio system will remain in place.

### Replacing the operating panel

- ⇒ Slide the operating panel into the guides from left to right.
- ⇒ Press the left-hand side of the panel onto the car audio system until it locks into place.

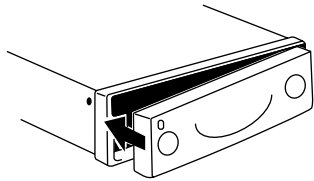

#### Note:

- While replacing the panel, be careful not to press on the display.

If the car audio system was on when you removed the panel, it will automatically switch back on using the same settings when you replace it (radio, CD player or CD changer).

# SCHWITCHING ON/OFF

---

## Switching the car audio system on/off

The car audio system can be switched on/off in a number of ways.

### Switching the car audio system on/off with the ignition

If the car audio system has been connected to your vehicle ignition, it is possible to switch it on and off with the ignition.

You can also switch the car audio system on when the ignition is switched off.

- ⇨ Press down and hold **3** until the car audio system switches on.

#### Note:

To prevent the car battery from running down, the radio will switch off again automatically after one hour.

### Switching the car audio system on/off with the removable front panel

- ⇨ Remove the release panel.

The car audio system will switch off.

- ⇨ Replace the release panel.

The car audio system will switch on again. The last settings used (radio, CD player or CD changer) will be activated.

### Switching the car audio system on/off by pressing **3**

- ⇨ Press **3** to switch the car audio system on.
- ⇨ Press **3** for longer than 2 seconds to switch the car audio system off again.

The system will then switch off.

### Switching the car audio system on by inserting a CD

If the system is switched off and there is no CD in the CD player,

- ⇨ press **9**.

The flip release panel will open.

- ⇨ Insert the CD into the CD player with the label facing up until you feel slight resistance. Do not use force.

The CD will be pulled automatically into the CD player.

Do not attempt to assist or prevent this process.

- ⇨ Press the operating panel closed gently until you feel it click into place.

The audio system will switch on. CD playback will begin.

## Volume control

The car audio system volume can be adjusted to levels from 0 (off) to 66 (maximum).

- ⇒ To increase the volume, turn the volume control knob (2) to the right.
- ⇒ To decrease the volume, turn the volume control knob (2) to the left.

## Adjusting the power-on volume

It is possible to adjust the volume at which the car audio system switches on.

- ⇒ Press **MENU** (8).
- ⇒ Press **Y** (10) repeatedly until "ON VOLUME" appears in the display.
- ⇒ Press **<>** (10) to adjust the volume.

If you adjust this setting to "0", the car audio system will switch on at the volume used before it was switched off.



### Warning of serious injury

If the power-on volume is set to the maximum level, it may be extremely loud when the car audio system is switched on.

If the power-on volume is set to 0 and the car audio system was played at maximum volume before it was switched off, it may be extremely loud when the car audio system is switched back on. This could result in serious injury to your ears!

- ⇒ Once you have selected the desired settings, press **MENU** (8) or **OK** (11).

## Mute

You can reduce the volume of the car audio system immediately (mute).

- ⇒ Press (3) briefly.
- "MUTE" will appear in the display.

## Selecting the mute level

It is possible to select the mute level.

- ⇒ Press **MENU** (8).
- ⇒ Press **Y** (10) repeatedly until "MUTE LEVEL" appears in the display.
- ⇒ Press **<>** (10) to select the mute level.
- ⇒ Once you have made your selection, press **MENU** (8) or **OK** (11).

## Telephone audio/Navigation audio

If your car audio system is equipped with a mobile telephone or a navigation system, it will automatically switch to mute when you use the phone or when voice output from the navigation system is emitted. The car speakers will then be used for the phone call or the voice output. This will not work unless the mobile phone or the navigation system is connected to the car audio system as described in the installation instructions. To find out which navigation systems can be used with your car radio, contact a Blaupunkt specialist dealer. The volume at which phone calls or navigation voice output are heard can be adjusted.

- ⇒ Press **MENU** (8).
- ⇒ Press **Y** (10) repeatedly until "TEL/NAVI VOL" appears in the display.



- ⇒ Press **<>** (10) to select the desired volume level.
- ⇒ Once you have made your selection, press **MENU** (8) or **OK** (11).

## Adjusting the volume of the beep

For a number of functions you will hear a beep if you press a key for longer than 2 seconds, e.g. if you want to store a radio station on a station preset. You can adjust the volume level of this beep.

- ⇒ Press **MENU** (8).
- ⇒ Press **V** (10) repeatedly until "BEEP" appears in the display.
- ⇒ Press **<>** (10) to adjust the volume. "0" means the beep volume is off, "9" means the beep volume is adjusted to the maximum volume.
- ⇒ Once you have adjusted the settings, press **MENU** (8) or **OK** (11).

## Radio operation

### Switching to the radio mode

If you are currently using the CD player or CD changer,

- ⇒ press **CD•C** (16) repeatedly until "RADIO" appears in the display.

### RDS function

This car audio system has been equipped with an RDS radio receiver. Many FM radio stations now transmit a signal which contains such other information as the station name along with their regular programming. As soon as the radio station name is detected, it will appear in the display. The RDS function can be switched on or off.

### Switching the RDS function on/off

- ⇒ To take advantage of the RDS function, press **RDS** (4).

When the RDS function has been activated, the RDS symbol will light up in the display.

### Selecting the waveband/ memory bank

The car audio system is able to receive FM and AM radio programs. There are three memory banks for the FM waveband and one memory bank for the AM waveband.

Up to six radio stations can be stored on each of the memory banks.

- ⇒ To switch between the FM memory banks, press **FM / TS** (5).
- ⇒ To select the AM waveband, press **AM** (15).

## Tuning into radio stations

You can tune into radio stations in a number of different ways.

### **Automatic seek tuning**

⇨ Press **Y** or **A** (10).

The radio will tune into the next available station within reception range.

### **Manual station selection**

You can also tune into radio stations manually.

⇨ Press **<** or **>** (10).

#### **Note:**

You cannot use manual tuning unless the RDS function is deactivated.

### **Paging through the broadcasting network (for FM only)**

If a radio broadcasting network has more than one station, you can page through the “station network”.

⇨ Press **<** or **>** (10) to tune into the next station in the network.

#### **Note:**

To take advantage of this function, you must have activated the RDS function.

It is only possible to tune into those stations which have been received once before already. To do this, use the SCAN or TravelStore function.

### **Adjusting seek tuning sensitivity**

It is possible to adjust the sensitivity of the seek tuning function to tune the radio into stations with strong reception signals only, or to those with weaker reception signals as well.

⇨ Press **MENU** (8).

⇨ Press **Y** (10) repeatedly until “SENS” appears in the display.

⇨ Press **>** (10).

The currently selected setting will appear in the display. “SENS HI” indicates the highest level of sensitivity, “SENS LO” the lowest. If you select “SENS LO”, “lo” will light up in the display.

⇨ Press **<** **>** (10) to select the desired sensitivity.

⇨ Once you have made your selection, press **MENU** (8) or **OK** (11).

## Storing radio stations

### **Storing radio stations manually**

⇨ Select the desired FM memory bank FM1, FM2, FMT or the AM waveband.

⇨ Tune the radio into the desired station.

⇨ Press and hold down one of the station preset buttons **1** to **6** (14) on which you want to store the radio station for longer than two seconds.

### **Storing radio stations automatically (TravelStore)**

You can automatically store the six radio stations with the strongest reception in your current reception area (for FM only). These stations will be stored in the FMT memory bank.

#### **Note:**

Any stations stored previously in the memory bank will be deleted.

# RADIO OPERATION

---

- ⇨ Press and hold down **FM / TS** (5) for longer than two seconds.

The storing process will begin. "TRAVEL-STORE" will appear in the display. After the stations have been stored, the radio will automatically begin to play the station stored on preset button 1 for the FMT memory bank.

## Recalling stored radio stations

- ⇨ Select the desired station memory bank.
- ⇨ Press the station button **1** to **6** (14) on which you have stored the desired radio station.

## Scanning the radio stations within reception range (SCAN)

You can scan all of the radio stations currently within your reception range. The scan time can be set in the menu to play from five to 30 seconds.

### **Starting SCAN**

- ⇨ Press and hold down **OK** (11) for longer than two seconds.

SCAN will begin. "SCAN" will appear briefly in the display, followed by the flashing station name or frequency of the radio station currently being scanned.

### **Stopping the SCAN function, continuing to listen to the radio station scanned**

- ⇨ Press **OK** (11).

SCAN will end and the last station scanned will continue playing.

## Adjusting the scan time

- ⇨ Press **MENU** (8).
- ⇨ Press **▼** (10) repeatedly until "SCANTIME" appears in the display.
- ⇨ Press **◀▶** (10) to set the scan time as desired.
- ⇨ Once you have made your selection, press **MENU** (8) or **OK** (11).

### **Note:**

The scan time selected also applies to the SCAN function for the CD player and the CD changer operation.

## Optimising radio reception

### **Interference-related treble cut (HICUT)**

The HICUT function improves reception when reception begins to deteriorate. If interference occurs, then the treble and the noise is cut automatically.

### **Switching HICUT on/off**

- ⇨ Press **MENU** (8).
- ⇨ Press **▼** (10) repeatedly until "HICUT" appears in the display.
- ⇨ Press **◀** or **▶** (10) to switch HICUT on or off.

"HICUT 0" indicates that the function is switched off; when "HICUT 3" appears, the treble will be automatically cut as far as possible.

- ⇨ Press **MENU** (8) or **OK** (11).

## Interference-dependent bandwidth switching (SHARX)

The SHARX function allows you to virtually eliminate interference from neighbouring radio stations. When you are in a reception area with a large number of radio station signals, switch the SHARX function on.

### **Switching SHARX on/off**

- ⇒ Press **MENU** (8).
- ⇒ Press **▼** (10) repeatedly until “SHARX” appears in the display.
- ⇒ Press **◀** or **▶** (10) to switch SHARX on or off.

“SHARX OFF” means no bandwidth switching, “SHARX ON” means automatic bandwidth switching.

- ⇒ Press **MENU** (8) or **OK** (11).

## Selecting the display of variable text

A number of radio stations use the RDS signal to transmit advertising or other texts in place of their station names. These “variable texts” will appear in the display. It is possible to adjust your radio so that these “variable texts” do not appear.

- ⇒ Press and hold down **RDS** (4) until “NAME FIX” appears in the display.
- ⇒ To have the “variable texts” displayed again, press and hold down **RDS** (4) until “NAME VAR” appears in the display.

## Adjusting the tuner

This car audio system has been equipped with a multiband tuner. The tuner can be adjusted to accommodate country-specific requirements. The available regions are: America, Europe, Asia and Thailand. The tuner is not fully functional unless it has been set to the country in which it is used.

### **Adjusting the tuner**

- ⇒ Press **MENU** (8).
- ⇒ Press **▼** (10) repeatedly until “FM TUNER” appears in the display.
- ⇒ Press **◀ ▶** (10) to select the country.
- ⇒ Once you have completed the setting, press **MENU** (8) or **OK** (11).

# CD PLAYER OPERATION

## CD player operation

The CD player in this car audio system can be used to play conventional music CDs with a diameter of 12 cm.

 Danger of damage to the CD player!

CD singles with a diameter of 8 cm and contour CDs (shape CDs) are not suitable for use with this CD player.

We assume no liability for any damage done to the CD player resulting from the use of unsuitable CDs.

### Starting CD player operation

- If there is no CD in the player,

⇨ press  (9).

The flip release panel will open.

⇨ Insert a CD into the player with the label facing up until you feel slight resistance. Do not use force.

The CD will be pulled into the player automatically.

Do not attempt to assist or prevent this process.

⇨ Press the operating panel closed gently until you feel it click into place.

The audio system will switch on. CD playback will begin.

- If there already is a CD inserted into the player,

⇨ press **CD•C** (16) repeatedly until "CD" appears in the display.

Playback will resume at the point where it was interrupted.

### Selecting tracks

⇨ Press a key on the cursor block (10) to select the next or the previous track.

Press **V** or **<** (10) once to restart the same track.

### Audible fast forward/reverse (CUE/REVIEW)

To start Cue or Review,

⇨ press and hold down either **<** or **>** (10) until the process begins.

### Playing tracks in random order (MIX)

⇨ Press **5 MIX** (14).

"MIX CD" will appear briefly in the display, the MIX symbol will light up in the display. The next track played will be selected at random.

### Stopping the MIX function

⇨ Press **5 MIX** (14) again.

"MIX OFF" will appear briefly in the display and the MIX symbol will no longer light up.

### Scanning tracks (SCAN)

You can scan all of the tracks on the CD.

⇨ Press **OK** (11) for longer than two seconds. Scanning will begin with the next track.

### Note:

It is possible to adjust the scan time. For more information, read the section on "Adjusting the scan time" in the chapter on "Radio Operation".

## CD PLAYER OPERATION

### Stopping the SCAN function, continue listening to the current track

- ⇒ To stop the SCAN function, press **OK** (11).

The track currently scanned will continue playing.

### Repeating individual tracks (REPEAT)

- ⇒ To repeat the track currently playing, press **4 RPT** (14).

“REPEAT TRCK” will appear in the display, the RPT symbol will light up. The track will continue to repeat until RPT is deactivated.

### Stopping the REPEAT function

- ⇒ If you want to stop the REPEAT function, press **4 RPT** (14) again.

“REPEAT OFF” will appear briefly in the display, the RPT symbol will no longer light up. CD playback will resume normally.

### Interrupting playback (PAUSE)

- ⇒ Press **3** (14).

“PAUSE” will appear in the display.

### Stopping PAUSE

- ⇒ Press **3** (14) during the pause.

Playback will resume.

### Switching the display mode

- ⇒ To switch the display between the track number and time or the track number and elapsed playing time or track number and CD name,

press **DIS** (7) for longer than two seconds once or repeatedly until the desired display becomes visible.

### Naming CDs

To help you to identify your CDs more easily, the car audio system allows you to individually name up to 30 CDs. The name can be made up of up to eight letters. If you attempt to enter more than 30 names, “FULL” will appear in the display.

### Entering/editing CD names

- ⇒ You are listening to the CD you want to name.
- ⇒ Press **MENU** (8).
- ⇒ Press **▲ ▼** (10) to select “CD NAME”.
- ⇒ Press **< >** (10) twice.

The car audio system is now in the edit mode. If the CD you selected does not yet have a name, eight dashes will appear in the display.

- ⇒ The first input position will flash.
- ⇒ Press **▲ ▼** (10) to select the letter you want to enter. If you want to leave this position blank, select the dash.
- ⇒ Press **< >** (10) to move the cursor to a different input position.
- ⇒ Press **MENU** (8) or **OK** (11) to store the name.

## CD PLAYER OPERATION

### Deleting a CD name

- ⇒ You are listening to a CD and would like to delete its name.
- ⇒ Press **MENU** (8).
- ⇒ Press **▲ ▼** (10) to select "CD NAME".
- ⇒ Press **<** or **>** (10).
- ⇒ Press and hold down **MENU** (8). After four seconds you will hear a beep and "DELETE NAME" will appear in the display.
- ⇒ Release **MENU** (8).

The CD name will be deleted.

- ⇒ Press **OK** (11) to return to the menu.

### Removing the CD

- ⇒ Press **⏏** (9) to activate the eject function.

The flip release panel will fold down, the CD will eject.

- ⇒ Remove the CD and close the operating panel.

## CD CHANGER OPERATION

### CD changer operation

#### Note:

For information on how to handle CDs, how to insert CDs into the changer and how to operate the changer, please refer to the instructions included with the CD changer.

### Starting CD changer operation

- ⇒ Press **CD•C** (16) repeatedly until "CHANGER" appears in the display.

Playback will begin with the first CD the changer detects in the magazine.

### Selecting CDs

- ⇒ To select a CD up or down in the magazine, press **▲** or **▼** (10) the required number of times.

### Selecting tracks

- ⇒ To select a different track on the CD currently playing, press **>** or **<** (10) the required number of times.

### Audible fast forward/reverse (CUE/REVIEW)

To start Cue or Review,

- ⇒ press and hold down either **<** or **>** (10) until the process begins.

### Switching the display mode

- ⇒ To switch the display between the track number and elapsed playing time or the track number and time, or track number and CD number or track number and CD name, press **⊙ / DIS** (7) for longer than two

seconds once or repeatedly as required, until the desired information appears in the display.

### Repeating individual tracks or entire CDs (REPEAT)

⇒ To repeat the track currently playing, press **4 RPT** (14) briefly.

“REPEAT TRCK” will appear briefly in the display, RPT will light up in the display.

⇒ To repeat the entire CD currently playing, press **4 RPT** (14) again.

“REPEAT DISC” will appear briefly in the display, RPT will light up in the display.

### **Stopping the REPEAT function**

⇒ To stop the REPEAT function for the current track or CD, press **4 RPT** (14) repeatedly until “REPEAT OFF” appears in the display and RPT no longer lights up.

### Playing tracks in random order (MIX)

⇒ To play the tracks of the currently selected CD in random order, press **5 MIX** (14) briefly.

“MIX CD” will appear briefly in the display, MIX will light up in the display.

⇒ To play the tracks of all of the CDs in random order, press **5 MIX** (14) again.

“MIX ALL” will appear briefly in the display, MIX will light up in the display.

### **Note:**

The CDC A 08 and the IDC A 09 are also able to play all of the CDs in the

changer in random order. The other CD changers first play all of the tracks on a CD in random order and then select the next CD in the changer.

### **Stopping the MIX function**

⇒ To stop the MIX function, press **5 MIX** (14) repeatedly until “MIX OFF” appears briefly in the display and MIX no longer lights up.

### Scanning all of the tracks on all of the CDs (SCAN)

⇒ To scan all of the tracks on all of the CDs in ascending order, press **OK** (11) for longer than two seconds.

“SCAN” will appear in the display.

### **Stopping the SCAN function**

⇒ To stop the SCAN function, press **OK** (11) briefly.

The track currently scanned will continue playing.

### **Note:**

It is possible to adjust the scan time. For more information, read the section on “Adjusting the scan time” in the chapter on “Radio Operation”.

### Interrupting playback (PAUSE)

⇒ Press **3** (14).

“PAUSE” will appear in the display.

### **Stopping PAUSE**

⇒ Press **3** (14) during the pause.

Playback will resume.



# CD CHANGER OPERATION

## Naming CDs

To help you to identify your CDs more easily, the car audio system allows you to individually name up to 99 CDs. The name can be made up of up to seven letters.

If you attempt to enter more than 99 names, "FULL" will appear in the display.

### Entering/editing CD names

- ⇒ Press **MENU** (8).
- ⇒ Press **▲ ▼** (10) to select "CDC NAME".
- ⇒ Press **<** or **>** (10).

The car audio system is now in selection mode.

- ⇒ Press **▲ ▼** (10) to select the CD you would like to name.
- ⇒ Press **<** or **>** (10).

Now you are in the edit mode. If the CD you selected does not yet have a name, seven dashes will appear in the display.

- ⇒ The first input position will flash.
- ⇒ Press **▲ ▼** (10) to select the letter you want to enter. If you want to leave this position blank, select the dash.
- ⇒ Press **<** or **>** (10) to move the cursor to a different input position.
- ⇒ Press **MENU** (8) or **OK** (11) to store the name.

### Deleting a CD name

- ⇒ You are listening to a CD and would like to delete its name.
- ⇒ Press **MENU** (8).

- ⇒ Press **▲ ▼** (10) to select "CDC NAME".
- ⇒ Press **<** or **>** (10).
- ⇒ Press and hold down **MENU** (8). After four seconds you will hear a beep and "DELETE NAME" will appear in the display.
- ⇒ Release **MENU** (8).

The CD name will be deleted.

- ⇒ Press **OK** (11) to return to the menu.

### Deleting all of the CD names

You want to delete all of the names entered for the CDs.

- ⇒ You are listening to a CD.
  - ⇒ Press **MENU** (8).
  - ⇒ Press **▲ ▼** (10) to select "CDC NAME".
  - ⇒ Press **<** or **>** (10).
  - ⇒ Press and hold down **MENU** (8). After four seconds you will hear a beep and "DELETE NAME" will appear in the display. Continue to hold down **MENU** (8) until you hear a second beep and "DELETE ALL" appears in the display.
  - ⇒ Release **MENU** (8).
- All of the CD names stored will be deleted.
- ⇒ Press **OK** (11) to return to the menu.

## CLOCK

### Displaying the clock briefly

- ⇒ To display the time briefly, press **⏻ / DIS** (7) briefly.

### Setting the time

The time can be set automatically by the RDS signal. If you are unable to receive an RDS radio station or if the RDS station you are listening to does not support this function, you can also set the time manually.

#### **Setting the time automatically**

- ⇒ To set the time automatically, press **MENU** (8).
- ⇒ Press **▼** (10) until "CLOCK MAN" (manual) or "CLOCK AUTO" (automatic) appears in the display.
- ⇒ Press **◀** (10) until "CLOCK AUTO" appears in the display.
- ⇒ Once you have made your selection, press **MENU** (8) or **OK** (11) twice.

When you tune into a radio station with the RDS clock function (RDS-CT), the time will be set automatically.

#### **Setting the time manually**

- ⇒ To set the time, press **MENU** (8).
- ⇒ Press **▼** (10) repeatedly until "CLOCKSET" appears in the display.
- ⇒ Press **▶** (10).

The time will appear in the display. The minutes will flash and can be altered.

- ⇒ Press **▲ ▼** (10) to alter the minutes.
- ⇒ Once you have altered the minutes, press **◀** (10). The hours will begin to flash.
- ⇒ Press **▲ ▼** (10) to alter the hours.
- ⇒ Press **MENU** (8) or **OK** (11).

### Selecting the 12/24-hour time display mode

- ⇒ Press **MENU** (8).
- "MENU" will appear in the display.
- ⇒ Press **▼** (10) repeatedly until "24 H MODE" or "12 H MODE" appears in the display.
- ⇒ Press **◀** or **▶** (10) to switch the display mode.
- ⇒ Once you have selected the mode, press **MENU** (8) or **OK** (11).

### Activating the clock for display when the car audio system is switched off

- ⇒ To activate the clock for display when the car audio system is switched off, press **MENU** (8).
- "MENU" will appear in the display.
- ⇒ Press **▼** (10) repeatedly until "CLK DISP OFF" or "CLK DISP ON" appears in the display.
- ⇒ Press **◀** or **▶** (10) to switch the clock display on or off.
- ⇒ Once you have made the setting, press **MENU** (8) or **OK** (11).

## Displaying the time briefly when the car radio is switched off

To display the time briefly when the car radio is switched off,

⇨ press **⏻** / **DIS** **(7)**.

The time will then appear in the display for eight seconds.

## Adjusting the tone and balance/fader

### Adjusting the bass

⇨ To adjust the bass, press **AUD / LD** **(13)**.

“BASS” will appear in the display.

⇨ Press **▲** or **▼** **(10)** to alter the bass.

### Adjusting the treble

⇨ To adjust the treble, press **AUD / LD** **(13)**.

“BASS” will appear in the display.

⇨ Press **▶** **(10)** until “TREBLE” appears in the display.

⇨ Press **▲** or **▼** **(10)** to alter the treble.

### Adjusting the balance

⇨ To adjust the balance, press **AUD / LD** **(13)**.

“BASS” will appear in the display.

⇨ Press **▶** **(10)** until “BALANCE” appears in the display.

⇨ Press **▲** or **▼** **(10)** to alter the balance.

### Adjusting the fader

⇨ To adjust the fader, press **AUD / LD** **(13)**.

“BASS” will appear in the display.

⇨ Press **▶** **(10)** until “FADER” appears in the display.

⇨ Press **▲** or **▼** **(10)** to alter the fader.

## Switching Loudness on/off

Loudness boosts the bass and treble when the volume is low to create a more natural sound.

- ⇨ Press **AUD / LD** (13) for approx. two seconds.

LD will light up in the display to indicate that Loudness is active.

## Adjusting Loudness intensity

The Loudness boost can be set in stages from one to six.

- ⇨ Press **MENU** (8).

“MENU” will appear in the display.

- ⇨ Press **V** (10) repeatedly until “LOUDNESS” appears in the display.

- ⇨ Press **◀** or **▶** (10) to alter the Loudness setting.

- ⇨ Once you have completed adjusting the settings, press **MENU** (8) or **OK** (11).

## Equalizer

This car audio system is equipped with a parametric digital equalizer. In this case, parametric means that it is possible to individually raise or lower **one** frequency (GAIN +10 to -20 dB) for each of the five filters.

The following filters are available:

- SUB LOW EQ 32 to 50 Hz
- LOW EQ 63 to 250 Hz
- MID EQ 315 to 1250 Hz
- MID/HIGH EQ 1600 to 6300 Hz
- HIGH EQ 8000 to 12500 Hz

These filters can be adjusted without the use of measuring equipment. As a result, it is possible to significantly influence the in-vehicle acoustics.

## Notes on making equalizer settings

We recommend that you use a CD you are familiar with to make the settings.

Before you set the equaliser, set bass, treble, balance and fader to “0” and deactivate the Loudness function. For more information on how to do this, refer to the section on “Tone and balance/fader”.

- ⇨ Now listen to the CD you have selected.
- ⇨ Evaluate the sound according to your own personal preferences.
- ⇨ Now refer to “Sound impression” in the following table.
- ⇨ Make the settings for the equalizer as described under “What to do”.

# EQUALIZER

---

## Switching the equalizer on/off

- ⇨ To switch the equalizer on, press and hold down **DEQ** (12) until EQ lights up in the display and “EQ ON” appears briefly.
- ⇨ To switch the equalizer off, press and hold down **DEQ** (12) until EQ no longer lights up in the display and “EQ OFF” appears briefly.

## Adjusting the equalizer

- ⇨ Press **DEQ** (12).
- ⇨ Press **▲** or **▼** (10) to select “DIGITAL EQ”.
- ⇨ Press **◀** or **▶** (10) to select the filter.
- ⇨ Press **▲** or **▼** (10).
- ⇨ To select the frequency, press **▶** (10).
- ⇨ To adjust the level, press **▲** or **▼** (10).
- ⇨ To select the next filter, first press **OK** (11) and then **◀** or **▶** (10).
- ⇨ Once you have completed making all of the necessary adjustments, press **DEQ** (12).

## Adjusting the spectrometer

The spectrometer in the display uses symbols to temporarily indicate what adjustments are made to the volume, the tone and balance/fader and the equalizer settings.

If no adjustments are being made to the system, the spectrometer displays the output level of the car radio.

You can select the type of spectrometer you want displayed in the menu. There are two different types available.

## Selecting the spectrometer type

- ⇨ Press **MENU** (8).
- “MENU” will appear in the display.
- ⇨ Press **▼** (10) repeatedly until “EQ DISPLAY” appears in the display.
  - ⇨ Press **◀** or **▶** (10) to select either “SPECTRUM 1”, “SPECTRUM 2” or “EQ DISP OFF”.
  - ⇨ Once you have completed adjusting the settings, press **MENU** (8) or **OK** (11).

## Assistance in setting your equaliser

Start to make your settings in the mid-range/treble and end it with the bass range.

Frequency range	Sound impression/problem	What to do
<b>Bass</b> 32 to 100 Hz	Bass reproduction too weak	Boost the bass with the "SUB LOW EQ", "LOW EQ" filter Frequency: 50 to 100 Hz Gain: +4 to +6 dB
<b>Lower mid-range</b> 100 to 400 Hz	Unclear bass Playback reverberates Unpleasant pressure on the ears	Reduce the lower midrange with the "LOW EQ", "MID EQ" filter Frequency: 125 to 400 Hz Gain: approx. -4 dB
<b>Mid-range sound</b> 400 to 4000 Hz	Sound appears to be too much in the foreground, very aggressive, no stereo effect	Reduce the mid-range with "MID EQ", "MID HIGH EQ" filter Frequency: 1000 to 2500 Hz Gain: -4 to -6 dB
<b>Treble</b> 4000 to 12500 Hz	Lifeless reproduction Lack of transparency Instruments do not sparkle	Boost treble range with "MID HIGH EQ", "HIGH EQ" filter Frequency: approx. 12500 Hz Gain: +2 to +4 dB

## External audio sources

In addition to the CD changer it is also possible to connect another external audio source to the line output. These sources can include a portable CD player, MiniDisc player or MP3 player.

If you have not connected a CD changer, it is possible to connect two external audio sources.

You must activate the AUX output in the menu.

If you would like to connect another external audio source, you will require an adapter cable. This adapter cable can be ordered from any authorized Blaupunkt dealer.

### Switching the AUX output on/off

⇒ Press **MENU** (8).

“MENU” will appear in the display.

⇒ Press **▼** (10) repeatedly until “AUX-IN-1 OFF” or “AUX-IN-1 ON” appears in the display.

In place of the “1”, there is a “2” for the second AUX input. If you have connected a CD changer, then only AUX “2” can be selected.

⇒ Press **◀** or **▶** (10) to switch AUX on or off.

⇒ Once you have completed your selections, press **MENU** (8) or **OK** (11).

#### **Note:**

If the AUX input has been switched ON, you can select it by pressing **CD•C** (16).

## Specifications

### Amplifier

Output power: 4 x 25 watts RMS  
acc. to DIN 45 324  
at 14.4 V  
4 x 40 watts max.  
power

### Tuner

Wavebands:

FM: 87.5 - 107.9 MHz

AM: 530 - 1710 kHz

FM Mono sensitivity:  
7.8 dBf

FM frequency response:  
30 - 15000 Hz

### CD player

Signal-to-noise ratio:  
96 dB

Frequency response:  
20 - 20000 Hz

### Preamp Out

4 channels: 4 V

Subject to technical modification!

## Service numbers / Numéros du service après-vente / Números de servicio / Número de serviço

	Tel.:	Fax:
Deutschland	0 18 05 00 02 25	0 51 21 49 40 02
Belgique / België	0 25 25 54 44	0 25 25 54 48
France	014 010 70 07	014 010 73 20
Nederland	023 565 63 48	023 565 63 31
Great Britain	018 958 383 66	018 958 383 94
Danmark	44 89 83 60	44 89 86 44
Sverige	08 750 15 00	08 750 18 10
Norge	66 81 70 00	66 81 71 57
Suomi	094 359 91	094 359 92 36
Österreich	01-6 10 39-0	01-6 10 39-391
Ελλάς	015 762 241	015 769 473
Česká republika	026 130 04 41	026 130 05 14
USA	800-266 25 28	708-681 71 88
Singapore	006 535 054 47	006 535 053 12
Slovensko	042 175 873 212	042 175 873 229

**Blaupunkt-Werke GmbH**  
**Bosch Gruppe**





Radio / CD

# Heidelberg CD50

Installation instructions  
Notice de montage  
Instrucciones de instalación  
Instruções de montagem



 **BLAUPUNKT**

# Installation instructions • Notice de montage • Instrucciones de instalación • Instruções de montagem

## **Safety instructions**

**When carrying out installation work and making connections please observe the following safety instructions:**

- Disconnect the negative terminal of the battery! When doing so, please observe the vehicle manufacturer's safety instructions.
- Make sure you do not damage vehicle components when drilling any holes.
- The cross sections of the positive and negative cables must not be less than 1.5 mm<sup>2</sup>.
- Incorrect installation may cause interference with electronic vehicle systems or your car radio.
- Do **not** connect the vehicle's plug connectors to the radio!
- You can obtain the adapter cable required for your vehicle type from any BLAUPUNKT dealer.

## **Consignes de sécurité**

**Respecter les consignes de sécurité suivantes pendant la durée du montage et du branchement.**

- Débrancher le pôle (-) de la batterie ! Respecter les consignes de sécurité du constructeur automobile !
- Veiller à n'endommager aucune pièce du véhicule en perçant des trous.

- La section du câble (+) et (-) ne doit pas dépasser 1,5 mm<sup>2</sup>.
- En cas d'erreur d'installation, des perturbations peuvent survenir dans les systèmes électroniques du véhicule ou dans votre autoradio.
- **Ne pas** brancher les connecteurs du véhicule sur la radio !
- Les câbles d'adaptation nécessaires pour le type de véhicule sont disponibles auprès des revendeurs BLAUPUNKT.

## **Normas de seguridad**

**Durante el montaje y la conexión es imprescindible observar las siguientes normas de seguridad.**

- Desemborne el polo negativo de la batería.  
Observe las normas de seguridad dadas por el fabricante del vehículo.
- Al perforar agujeros, asegúrese de no dañar ninguna pieza del vehículo.
- La sección transversal del cable positivo y del cable negativo no debe ser menor de 1,5 mm<sup>2</sup>.
- Una instalación incorrecta puede provocar perturbaciones en los sistemas electrónicos del vehículo o en la radio.
- ¡**No** conecte a la radio los conectores ubicados en el vehículo!

- Los cables adaptadores necesarios para su vehículo los encontrará en el comercio especializado en artículos de la marca BLAUPUNKT.

**P** **⚠ Instruções de segurança**

**Durante a montagem e a ligação do aparelho, queira respeitar as seguintes instruções de segurança.**

- Separar o pólo negativo da bateria! Respeitar ao mesmo tempo as instruções de segurança do fabricante do automóvel.
- Quando se procede à furagem de buracos, prestar atenção para não serem danificadas quaisquer partes do veículo.
- As secções transversais dos cabos positivo e negativo não devem ser inferiores a 1,5 mm<sup>2</sup>.
- Se a montagem for executada de forma incorrecta podem ocorrer avarias nos sistemas electrónicos do automóvel ou no seu auto-rádio.
- **Não** ligar as fichas existentes do lado do automóvel ao auto-rádio!
- Os cabos adaptadores necessários para o seu automóvel podem ser adquiridos nos revendedores da BLAUPUNKT.

**Supplied Mounting Hardware**  
**Materiel de montage fourni**  
**Ferreteria de montaje**  
**suministrada**

**Elementos de fixação**  
**fornecidos.**

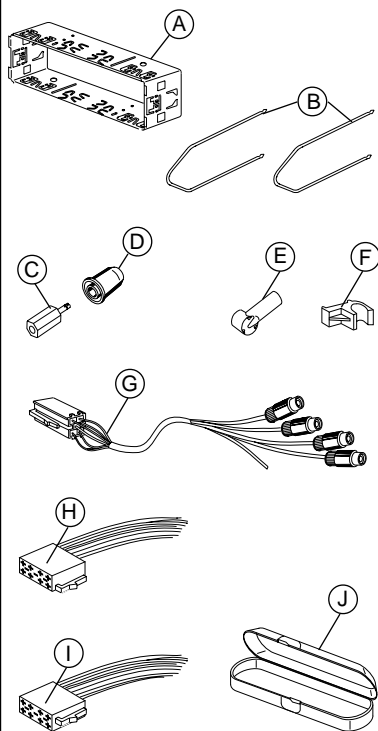

1.

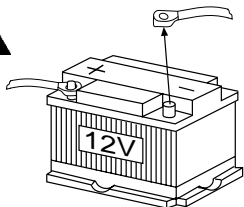

2.

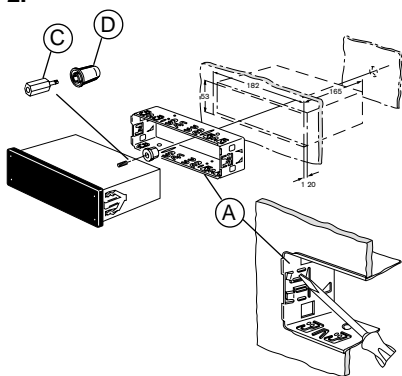

3.

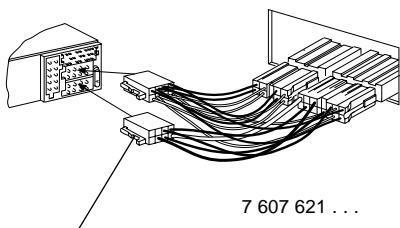

Car-specific adapter cable which is available at your dealer.

Câble adaptateur spécifique au véhicule, disponible dans le commerce.

Adaptador específico del vehículo, el cual se puede adquirir en el comercio especializado.

Cabo de adaptação específico do automóvel que pode ser adquirido no comércio especializado.

4.

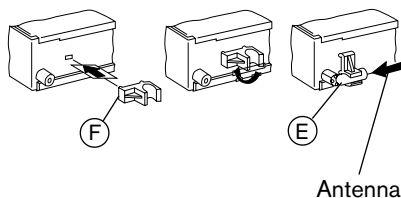

5.

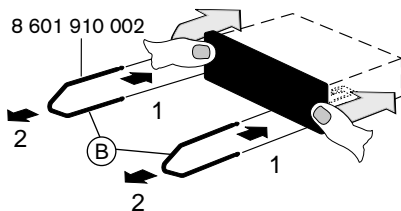

6.

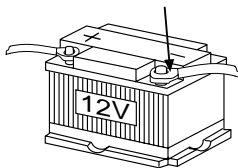

7.

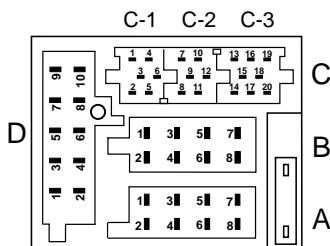

A		B	
1	Automatic Sound	1	Speaker out RR+
2	Radio Mute	2	Speaker out RR-
3	nc	3	Speaker out RF+
4	Permanent +12V	4	Speaker out RF-
5	Aut. antenna	5	Speaker out LF+
6	Illumination	6	Speaker out LF-
7	Kl.15/Ignition	7	Speaker out LR+
8	Ground	8	Speaker out LR-

D	
1	AUX 2- NF L
2	AUX 2- NF R
3	AUX 2- REF
4	NC
5	NC
6	NC
7	NC
8	NC
9	NC
10	NC

C					
C1		C2		C3	
1	Line Out LR	7	Telefon / Navi NF in +	13	Bus - In
2	Line Out RR	8	Telefon / Navi NF in -	14	Bus - Out
3	Line Out Masse / Ground	9	Radio / Navi Mute	15	Permanent +12V
4	Line Out LF	10	⚡ FB +12V / RC +12V	16	⚡ +12V
5	Line Out RF	11	Fernbedienung / Remote Control	17	Bus - Masse / GND
6	⚡ +12V Amplifier	12	FB - Masse / RC - GND	18	AF - Masse / GND
				19	Line In - L
				20	Line In - R

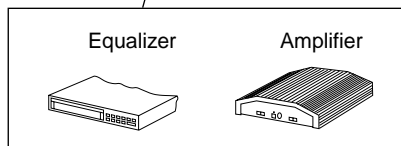

Remote Control

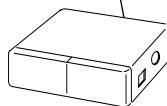

CD-Changer

